

CAVITY ID

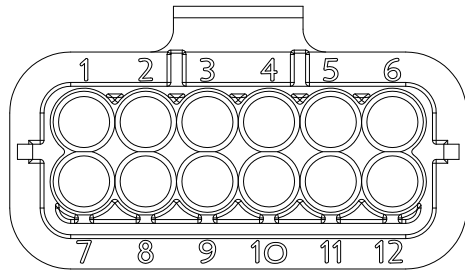

HOUSING AND SEAL SOLD

(EXAMPLES OF AN ASSEMBLED PART)

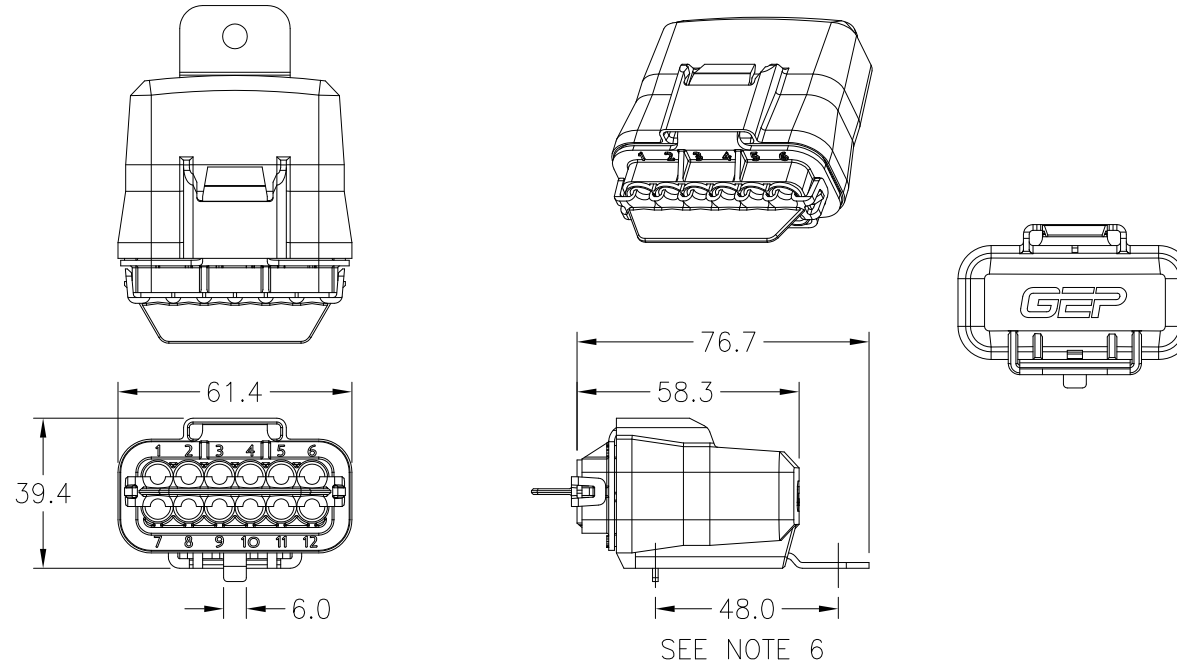

SHOWN ABOVE

ABOVE - FRH-A12, FRH-A12-C (COVER), FRH-A12-MB-AX (BRACKET), & FRH-A12-T (TPA)

FRH-A12  
HOUSING AND SEAL SOLD  
AS ONE UNIT

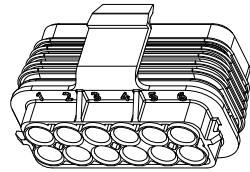

FRH -  
COVER OPTIONS

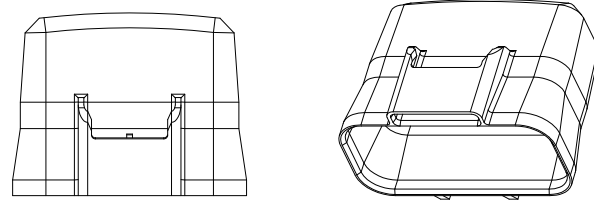

FRH-A12-C  
(BRACKETED COVER) NOTE 5

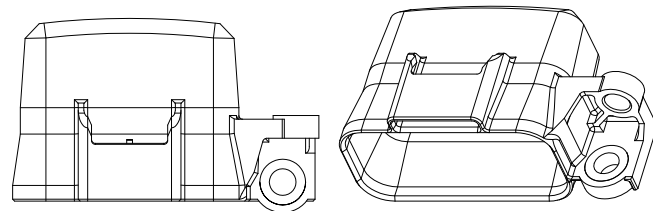

FRH-A12-CB-1  
(SINGLE SIDE MOUNT COVER)

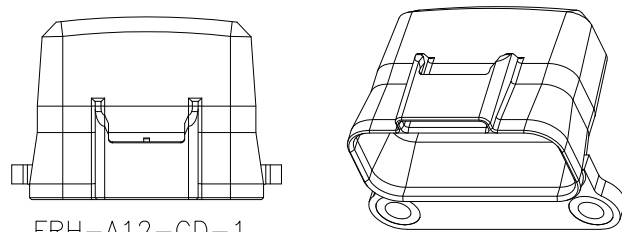

FRH-A12-CD-1  
(DOUBLE SIDE MOUNT COVER)

FRH -  
ACCESSORY OPTIONS

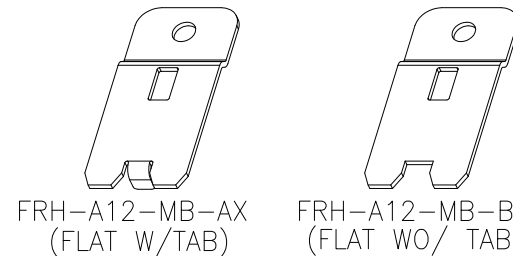

FRH-A12-MB-AX  
(FLAT W/TAB)

FRH-A12-MB-BX  
(FLAT WO/ TAB)

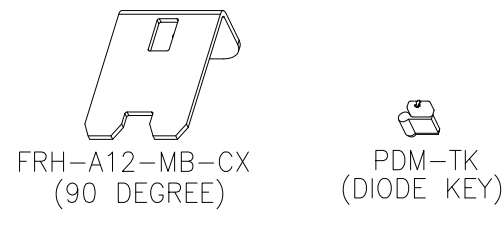

FRH-A12-MB-CX  
(90 DEGREE)

PDM-TK  
(DIODE KEY)

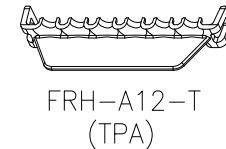

FRH-A12-T  
(TPA)

NOTES:

1. BASE & COVER MATERIAL: UNFILLED PBT
2. TPA & KEY MATERIAL: UNFILLED NYLON
3. BRACKET MATERIAL: ZINC PLATED STEEL OR STAINLESS STEEL (SEE CHART)
4. DESIGNED TO USE DELPHI 280 METRI-PACK TERMINALS AND SEALS (SEE TABLE A)
5. PICK BRACKET OPTION TO MOUNT ASSEMBLY
6. MOUNTING HOLE TO ANTI-ROTATION TAB DIM.

PART NO. FRH-A12-XX-XX (SALES)				
TITLE FUSE / RELAY HOLDER				
CUSTOMER STANDARD				
ENGLISH (IN)				SCALE 1:2
REV #	REVISION	DATE	BY	APPROVE
X0	RELEASED FOR REVIEW	09-17-2015	XX	
X1	ECO 7961 UPDATED TO A NEW FORMAT FOR EASIER ORDERING	02-15-2016	RR	JL

TABLE A

TERMINALS / SEALS FOR HOUSING				
DELPHI 280 METRI-PACK TERMINALS				
PART #	RANGE (mm2)	MATERIAL	PLATING	
12077413	5.0	TIN BRASS	TIN	
12129493	2.0-3.0	TIN BRASS	TIN	
12077411	0.8-1.0	TIN BRASS	TIN	
12084201	0.35-0.50	TIN BRASS	TIN	
12176387	5.0	BERYLIUM COPPER	SILVER/NICKEL	
12176388	2.0-3.0	BERYLIUM COPPER	SILVER/NICKEL	
12176389	0.8-1.0	BERYLIUM COPPER	SILVER/NICKEL	
DELPHI 280 METRI-PACK CABLE SEALS				
PART # REEL	PART # LOOSE	CABLE DIA	MATERIAL	COLOR
12015360	12015193	3.45-4.3	SILICONE	BLUE
12015359	12010293	2.81-3.49	SILICONE	LT. GRAY
12015284	12015323	2.03-2.85	SILICONE	GREEN
12041352	12041351	2.03-2.42	SILICONE	TAN
12089444	12089679	1.6-2.15	SILICONE	PURPLE
12034365	12015899	1.29-1.70	SILICONE	DK. RED
	12010300	PLUG	SILICONE	GREEN



16830 Pheasant Drive  
Brookfield, WI 53005

CONFIDENTIAL - The information contained in this document is the property of GEP Power Products. It is not for public disclosure. Possession of the information does not convey any right to loan, sell or disclose the information. Unauthorized reproduction or use of the information is prohibited. This document is to be returned to GEP Power Products upon completion of the purpose for which it is loaned or upon request.

COPYRIGHT - GEP Power Products  
This is an unpublished work. The disclosure of this work is limited to a select personnel. Further dissemination or disclosure to the public is PROHIBITED. This unpublished work is protected by Federal Copyright law and all rights thereunder are reserved by GEP Power Products.

TOLERANCES  
UNLESS OTHERWISE SPECIFIED

METRIC TOL	ENGLISH TOL
1 PL DEC.=±.25	2 PL DEC.=±.01
2 PL DEC.=±.13	3 PL DEC.=±.005

THIRD ANGLE PROJECTION



ANGULAR TOL= ±2°  
FRACTION TOL= ± 1/64 IN